

N 32 / N 40 / N 50 / N 65 / N 80

Elettropompe monoblocco Close coupled pumps Electropompes monobloc

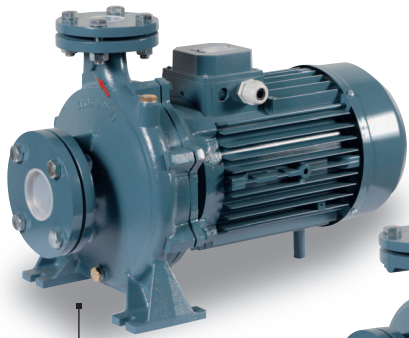

N 40

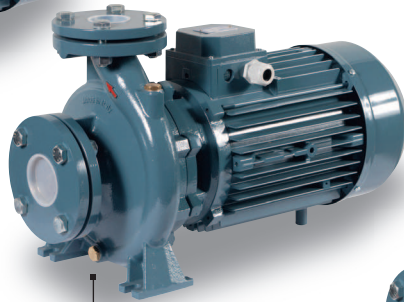

N 50

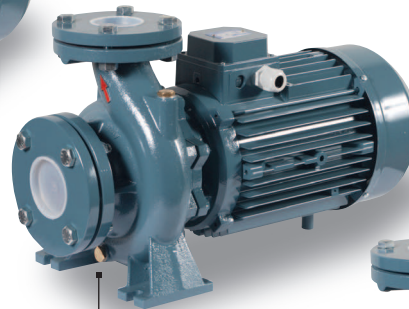

N 65



N 80

Elettropompe normalizzate
costruite secondo norme DIN 24255

N	80	160 B
Tipo	Mandata	N° curva
Type	Outlet	N° curve
Type	Bouche de refoulement	N° curve

UTILIZZO: Elettropompe a girante radiale con bocca di aspirazione assiale e bocca di mandata radiale rivolta verso l'alto. La caratteristica principale di questa serie è di sviluppare portate medio-alte con prevalenze altrettanto buone. Trattasi di elettropompe ad una sola girante indicate per usi industriali, agricoli e domestici. Nell'impiego di queste elettropompe è consigliabile l'uso di liquidi chimicamente e meccanicamente puliti, con temperatura non superiore agli 80°C.

POMPA: Pompa ad asse orizzontale con girante in ottone per la N 32-160 A-B e in ghisa per tutte le altre, corpo pompa e supporto in ghisa G20, albero in acciaio INOX AISI 304 e tenuta meccanica in ceramica/grafite.

MOTORE: Elettrico di tipo chiuso a ventilazione esterna, grado di protezione IP44. Classe di isolamento F.

TENSIONI: 3 kW e 4 kW: 230/400 V. 50 Hz; da 5,5 kW a 22 kW: 400/690 V. 50 Hz. A richiesta sono disponibili tensioni e frequenze diverse.

SCOPE OF APPLICATION: Radial impeller pumps with axial intake and upward-facing radial delivery. The main feature of these pumps is that they are capable of generating medium-high flow rates and high discharge heads. These single-impeller pumps are particularly suited for industrial, agricultural and domestic applications. It is recommended that these pumps are used to carry only chemically pure liquids and free of foreign matters, with temperatures not higher than 80°C.

PUMP: Horizontal axis pump with brass impeller for the model N 32-160 A-B and cast iron for all the others, pump body and base support made of G20 cast iron, AISI 304 stainless steel shaft and mechanical seal in ceramic/graphite.

MOTOR: Electric, closed-type with external cooling fan, IP44 protection degree. Class F insulation.

TENSION: 3 kW and 4 kW: 230/400 V. 50 Hz; from 5,5 kW to 22 kW: 400/690 V. 50 Hz. Different voltage and frequency ratings are available on request.

UTILISATION : Pompes à couronne radiale, ayant une bouche d'aspiration axiale et une bouche de refoulement radiale tournée vers le haut. La principale caractéristique de cette série c'est d'avoir des débits moyen-hauts avec des élévations aussi bonnes. Elles sont indiquées pour des utilisations industrielles, agricoles et privées car ce sont des électropompes à une seule couronne. Lors de l'utilisation de ces électropompes il est conseillé d'employer des liquides chimiquement et mécaniquement propres et à des températures ne dépassant pas 80°C.

POMPE : Pompe à axe horizontal avec couronne en laiton pour N 32-160 A-B et en fonte pour toutes les autres, corps de pompe et support en fonte G20, arbre en acier INOX AISI 304 et tenue mécanique en céramique/graphite.

MOTEUR : Electrique de type fermé à ventilation extérieure, degré de protection IP44. Classe d'isolation F.

TENSION : 3 kW et 4 kW: 230/400 V. 50 Hz; de 5,5 kW à 22 kW: 400/690 V. 50 Hz. Sur demande les tensions et les fréquences peuvent être différentes.

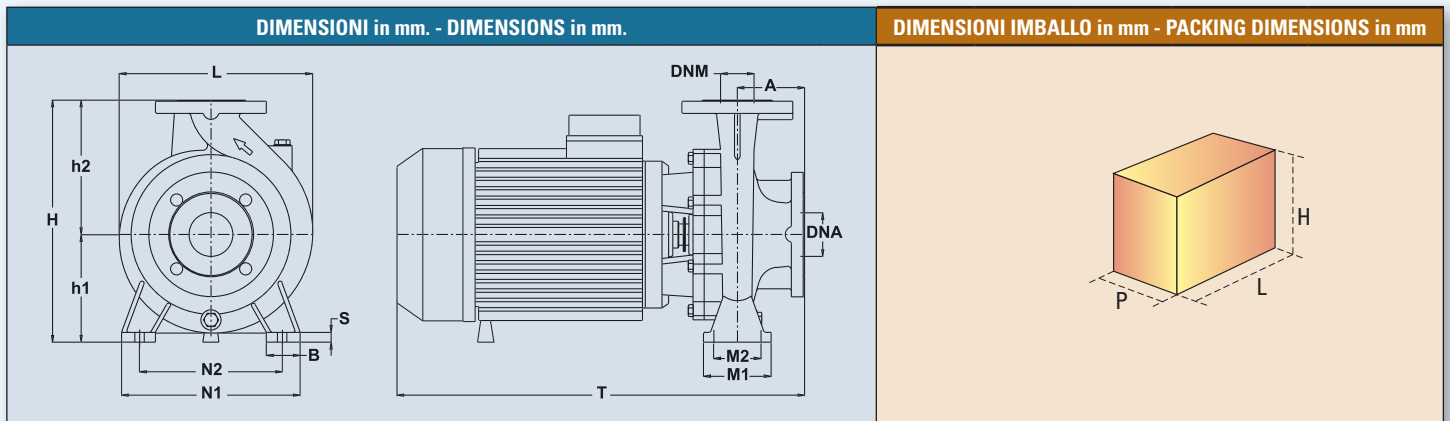

TIPO - TYPE	A	H	h1	h2	L	M1	M2	N1	N2	B	S	T	DNA	DNM	L	H	P	PESI - WEIGHT Kg	
																		Pompa - Pump	Imballo - Pack
N 32-160 B	80	340	160	180	260,5	100	70	240	190	50	14	450	50	32	540	360	290	43,5	1,3
N 32-160 A	80	340	160	180	260,5	100	70	240	190	50	14	450	50	32	540	360	290	46,1	1,3
N 32-200 B	80	340	160	180	268	100	70	240	190	50	15	541	50	32	660	600	350	65	6,1
N 32-200 A	80	340	160	180	268	100	70	240	190	50	15	541	50	32	660	600	350	72	6,1
N 40-160 B	80	292	132	160	245,5	100	70	240	190	50	15	460	65	40	540	360	290	45,1	1,3
N 40-160 A	80	292	132	160	245,5	100	70	240	190	50	15	460	65	40	540	360	290	48,0	1,3
N 40-200 B	100	340	160	180	275	100	70	265	212	50	15	560	65	40	660	600	350	69,5	6,1
N 40-200 A	100	340	160	180	275	100	70	265	212	50	15	560	65	40	660	600	350	75,2	6,1
N 40-250 B	100	405	180	225	310	125	95	320	250	65	15	600	65	40	660	600	350	94,0	6,1
N 40-250 A	100	405	180	225	310	125	95	320	250	65	15	600	65	40	660	600	350	98,0	6,1
N 50-125 B	100	292	132	160	228	100	70	240	190	50	14	482	65	50	540	360	290	45,3	1,3
N 50-125 A	100	292	132	160	228	100	70	240	190	50	14	482	65	50	540	360	290	47,8	1,3
N 50-160 B	100	340	160	180	256	100	70	265	212	50	14	560	65	50	660	530	350	67,5	6,1
N 50-160 A	100	340	160	180	256	100	70	265	212	50	14	560	65	50	660	530	350	72,6	6,1
N 50-200 C	100	360	160	200	287	100	70	265	212	50	15	565	65	50	660	530	350	83,0	6,1
N 50-200 B	100	360	160	200	287	100	70	265	212	50	15	605	65	50	660	530	350	85,0	6,1
N 50-200 A	100	360	160	200	287	100	70	265	212	50	15	605	65	50	660	530	350	94,5	6,1
N 50-250 B	100	405	180	225	332	125	95	320	250	65	15	724,50	65	50	810	530	360	135	9
N 50-250 A	100	405	180	225	332	125	95	320	250	65	15	724,50	65	50	810	530	360	145	9
N 65-125 B	100	340	160	180	252	125	95	280	212	65	15	565	80	65	660	530	350	70,0	6,1
N 65-125 A	100	340	160	180	252	125	95	280	212	65	15	565	80	65	660	530	350	75,3	6,1
N 65-160 C	100	360	160	200	269	125	95	280	212	65	15	565	80	65	660	530	350	82,0	6,1
N 65-160 B	100	360	160	200	269	125	95	280	212	65	15	605	80	65	660	530	350	92,5	6,1
N 65-160 A	100	360	160	200	269	125	95	280	212	65	15	605	80	65	660	530	350	96,6	6,1
N 65-200 B	100	405	180	225	330	125	95	320	250	65	15	725	80	65	810	530	360	135	9
N 65-200 A	125	405	180	225	330	125	95	320	250	65	15	725	80	65	810	530	360	145	9
N 65-250 B	100	450	200	250	370	160	120	360	280	80	16	850	80	65	850	490	380	239	10
N 65-250 A	100	450	200	250	370	160	120	360	280	80	16	850	80	65	850	490	380	253	10
N 80-160 F	125	405	180	225	328	125	95	320	250	65	15	595	100	80	660	530	350	82,0	6,1
N 80-160 E	125	405	180	225	328	125	95	320	250	65	15	595	100	80	660	530	350	93,0	6,1
N 80-160 D	125	405	180	225	328	125	95	320	250	65	15	635	100	80	660	530	350	97,0	6,1
N 80-160 C	125	405	180	225	328	125	95	320	250	65	15	635	100	80	660	530	350	117,0	6,1
N 80-160 B	125	405	180	225	330	125	95	320	250	65	15	755	100	80	810	530	360	140	9
N 80-160 A	125	405	180	225	330	125	95	320	250	65	15	755	100	80	810	530	360	150	9
N 80-200 B	125	405	180	250	355	125	95	345	280	65	16	840	100	80	850	490	380	233	10
N 80-200 A	125	405	180	250	355	125	95	345	280	65	16	840	100	80	850	490	380	247	10

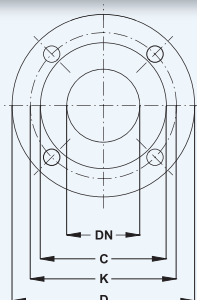

Dimensioni Flange in mm - Flanges Dimensions in mm					
DN	K	D	C	FORI - HOLES	
				N°	Ø
32	100	140	78	4	18
40	110	150	88	4	18
50	125	165	102	4	18
65	145	185	122	4	18
80	160	200	138	4	18
100	180	220	158	8	18

I valori descritti si intendono di produzione media. La Ditta si riserva di apportare qualsiasi variazione senza obbligo di preavviso.
The figures in the tables are averages for production models. The Company reserves the right to carry out changes of any kind without prior notice.

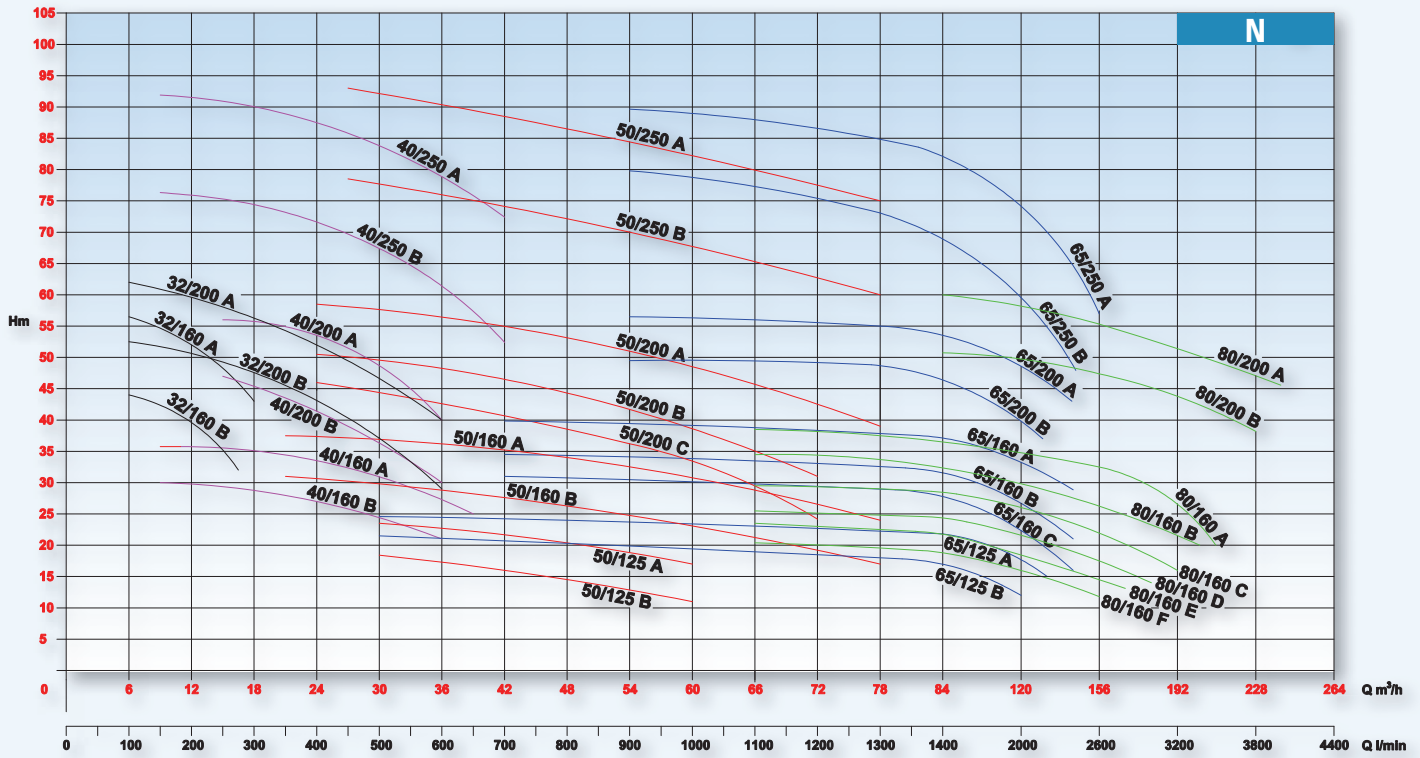

Hm = Prevalenza Q = Capacità
Hm = Head Q = Capacity

COMPONENTI - ELEMENTS

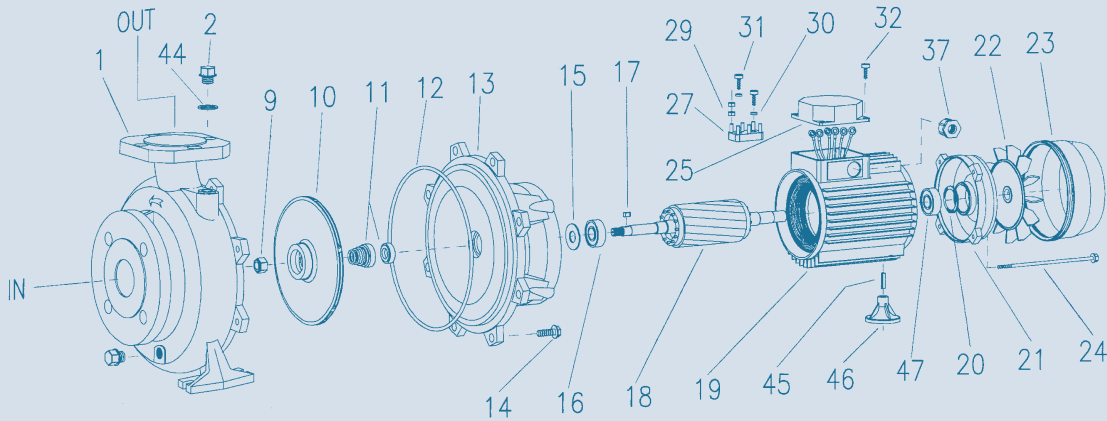

N	DESCRIZIONE - DESCRIPTION	MATERIALE - MATERIAL	N	DESCRIZIONE - DESCRIPTION	MATERIALE - MATERIAL
1	Corpo pompa - Pump body	Ghisa G20 - G20 Cast iron	22	Ventola di raffreddamento - Cooling fan	Plastica - Plastic
2	Tappo 1/4" GAS - Screw plug 1/4" GAS	Ottone - Brass	23	Copriventola - Fan cover	Lega - Light alloy
9	Dado autobloccante - Self-locking nut	Ottone - Brass	24	Tirante - Tie rod	FE 8.8
10	Girante - Impeller (N 32/160 A-B)	Ottone - Brass	25	Coprimorsettiera - Box	Alluminio - Aluminium
11	Girante - Impeller (N 32/200 A-B - N40 - N50 - N65 - N80)	Ghisa G20 - G20 Cast iron	27	Morsettiera - Terminal box	Lega speciale - Special alloy
11	Tenuta mecc. (fissa - mobile) - Mech. seal (fixed - mobile)	Ceram./graf. - Ceram./graph.	29	Dado di fissaggio morsettiera - Nut for connecting terminal	Ottone - Brass
12	Anello - O'ring	Gomma nitril. - Nitril. rubber	30	Rondella - Washer	Ottone - Brass
13	Supporto - Motor bracket	Ghisa G20 - G20 Cast iron	31	Vite autofilettante - Self-threading screw	FE 8.8
14	Vite - Screw	FE 8.8	32	Vite autofilettante - Self-threading screw	FE 8.8
15	Paraspizzo - Splash ring	Gomma Telata - Rubber	37	Pressacavo - Electric cable press	Plastica - Plastic
16	Cuscinetto - Bearing	AISI 316	44	Rondella per tappi - Washer screw plug	FE 8.8
17	Chiavetta - Key	AISI 316	45	Spina cilindrica - Pin	AISI 316
18	Albero motore + rotore - Driving shaft + rotor	AISI 304	46	Piedino - Foot	Plastica - Plastic
19	Cassa motore + statore - Motor case + stator	Alluminio - Aluminium	47	Cuscinetto - Bearing	AISI 316
20	Anello reggispinta - Ring	Acciaio - Steel			
21	Scudo - Shield	Alluminio - Aluminium			

I valori descritti si intendono di produzione media. La Ditta si riserva di apportare qualsiasi variazione senza obbligo di preavviso.
The figures in the tables are averages for production models. The Company reserves the right to carry out changes of any kind without prior notice.